

# STANDART OPENCELL

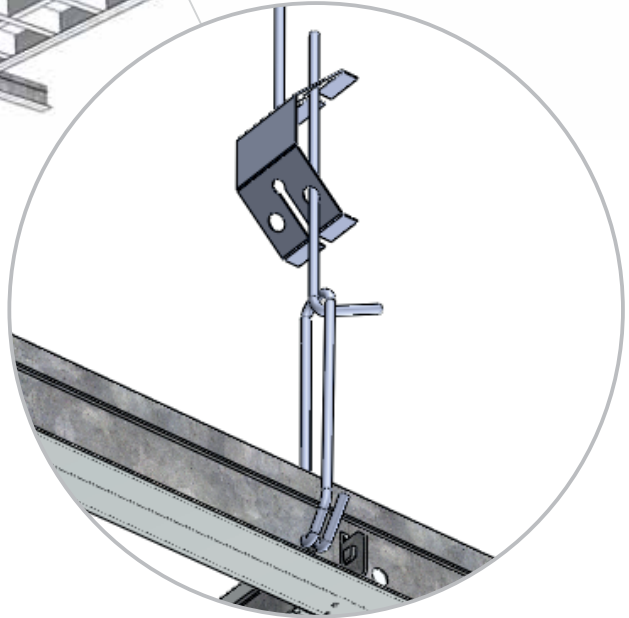

Rectangle  
50X150mm

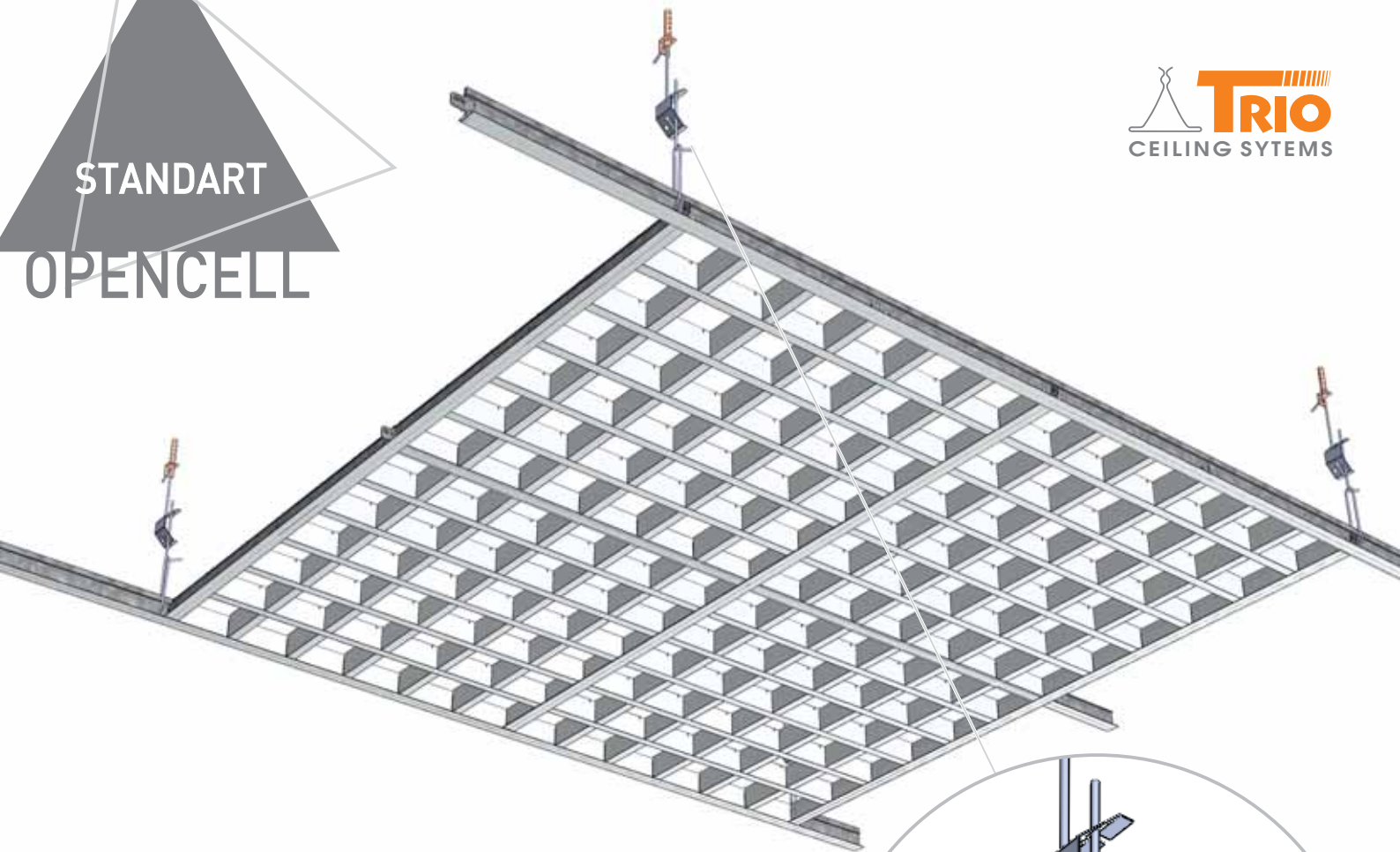
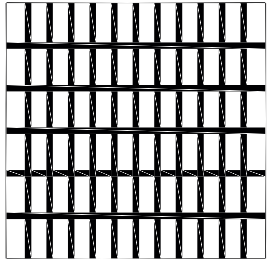

50mm

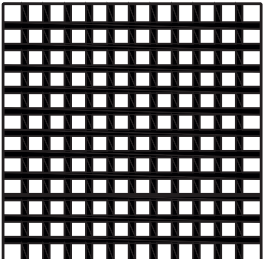

60mm

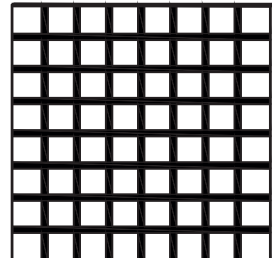
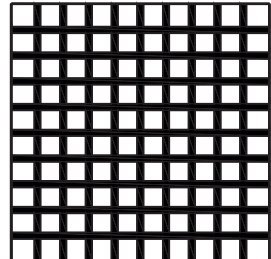

75mm

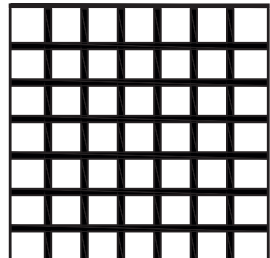

85mm

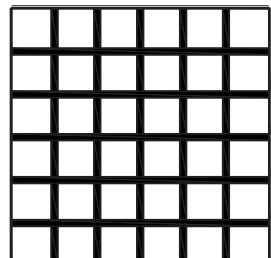

100mm

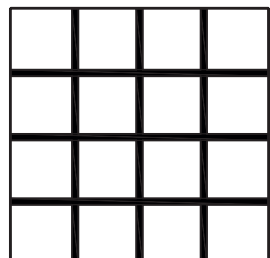

150mm

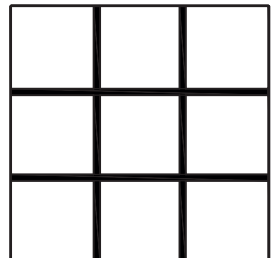

200mm

RAW MATERIAL	BASE	HEIGHT	COLOR	EYE RANGE
Aluminium	15 mm	40 mm	Standart Ral 9005 - Ral 9016 - Ral 7016 Other Ral Options Wooden Looked Colors	50x150mm Rcnt 50x50 mm 60x60 mm 75x75 mm 85x85 mm 100x100 mm 150x150 mm 200x200 mm

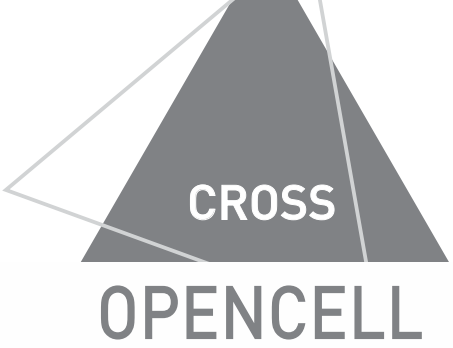

It's the same system as open cell system. The only difference is a diagonal part is attached into open cell area. This system also comes with T-15 carrier system which is easy to install. This system is modular so you can reach background of the system easily.

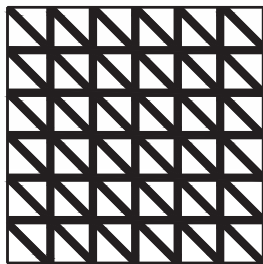

100 mm

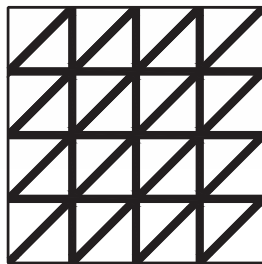

150 mm

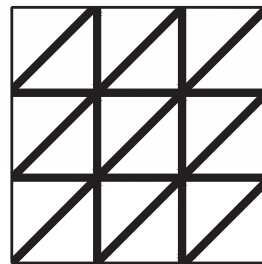

200 mm

RAW MATERIAL	BASE	HEIGHT	COLOR	EYE RANGE
Aluminium	15 mm	40 mm	Standart Ral 9005 - Ral 9016 - Ral 7016 Other Ral Options	100x100 mm 150x150 mm 200x200 mm

Wooden Looked Colors